



SAW Components

Data Sheet X 7256 D





SAW Components

X 7256 D

Bandpass Filter

57,00 MHz

Data Sheet

Duroplast package **SIP5D**

Features

- IF filter for ISDB-T
- Switchable between two bandwidths
- Standard IC package

Terminals

- Tinned CuFe alloy

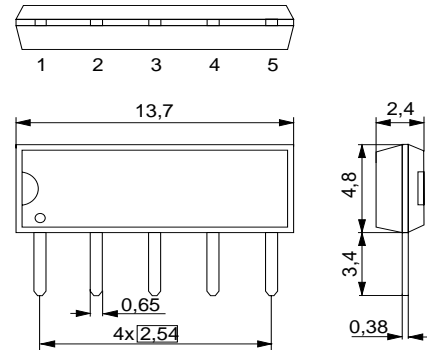

Dimensions in mm, approx. weight 0,5 g

Pin configuration

- 1 Input
- 2 Switching input
- 3 Chip carrier – ground
- 4 Output
- 5 Output

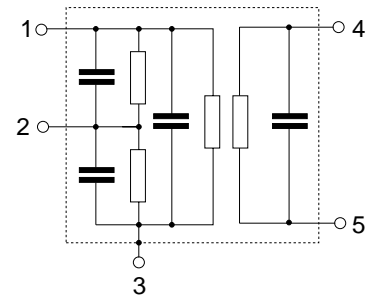

Type	Ordering code	Marking and package according to	Packing according to
X 7256 D	B39570-X7256-N201	C61157-A1-A21	F61074-V8049-Z000

Maximum ratings

Operable temperature range	T_A	-25/+65	°C	
Storage temperature range	T_{stg}	-40/+85	°C	
DC voltage	V_{DC}	5	V	between any terminals
AC voltage	V_{pp}	10	V	between any terminals



SAW Components	X 7256 D
Bandpass Filter	57,00 MHz

Data Sheet

Characteristics of channel 1 (switching pin 2 connected to ground)

Reference temperature: $T_A = 25 (45) \text{ }^\circ\text{C}$
 Terminating source impedance: $Z_S = 50 \text{ } \Omega$
 Terminating load impedance: $Z_L = 2 \text{ k}\Omega \parallel 3 \text{ pF} \parallel 3 \text{ pF}$

		min.	typ.	max.	
Insertion attenuation	α				
Reference level for the following data	57,08 (57,00) MHz	12,0	13,5	15,0	dB
Pass bandwidth					
$\alpha_{\text{rel}} \leq 3 \text{ dB}$	$B_{3\text{dB}}$	—	6,0	—	MHz
$\alpha_{\text{rel}} \leq 30 \text{ dB}$	$B_{30\text{dB}}$	—	7,5	—	MHz
Relative attenuation	α_{rel}				
	54,53 (54,45) MHz	-0,9	0,1	1,1	dB
	59,53 (59,45) MHz	-1,0	0,0	1,0	dB
	54,03 (53,95) MHz	—	3,1	—	dB
	60,03 (59,95) MHz	—	2,8	—	dB
	60,39 (60,31) MHz	—	11,0	—	dB
Lower sidelobe					
	45,08 ... 52,08 (45,00 ... 52,00) MHz	36,0	44,0	—	dB
	52,08 ... 53,03 (52,00 ... 52,95) MHz	38,0	46,0	—	dB
Upper sidelobe					
	60,88 ... 62,58 (60,80 ... 62,50) MHz	28,0	34,0	—	dB
	62,58 ... 65,08 (62,50 ... 65,00) MHz	37,0	43,0	—	dB
Reflected wave signal suppression					
1,2 μs ... 6,0 μs after main pulse (test pulse 250 ns, carrier frequency 57,08 MHz)		42,0	52,0	—	dB
Feedthrough signal suppression					
1,3 μs ... 1,2 μs before main pulse (test pulse 250 ns, carrier frequency 57,08 MHz)		—	50,0	—	dB
Group delay ripple (p-p)	$\Delta\tau$				
54,53 ... 59,53 (54,45 ... 59,45) MHz		—	60	—	ns
Impedance at 57,08 MHz					
Input: $Z_{\text{IN}} = R_{\text{IN}} \parallel C_{\text{IN}}$		—	0,4 19,0	—	k Ω pF
Output: $Z_{\text{OUT}} = R_{\text{OUT}} \parallel C_{\text{OUT}}$		—	0,6 6,0	—	k Ω pF
Temperature coefficient of frequency	TC_f	—	-72	—	ppm/K



SAW Components

X 7256 D

Bandpass Filter

57,00 MHz

Data Sheet

Characteristics of channel 2 (switching pin 2 connected to pin 1)

Reference temperature: $T_A = 25 (45) \text{ }^\circ\text{C}$
 Terminating source impedance: $Z_S = 50 \text{ } \Omega$
 Terminating load impedance: $Z_L = 2 \text{ k}\Omega \parallel 3 \text{ pF} \parallel 3 \text{ pF}$

		min.	typ.	max.	
Insertion attenuation					
	α				
Reference level for the following data	57,08 (57,00) MHz	10,7,	12,2	13,7	dB
Pass bandwidth					
$\alpha_{\text{rel}} \leq 3 \text{ dB}$	$B_{3\text{dB}}$	—	4,1	—	MHz
$\alpha_{\text{rel}} \leq 30 \text{ dB}$	$B_{30\text{dB}}$	—	5,6	—	MHz
Relative attenuation					
	α_{rel}				
	55,18 (55,10) MHz	—	0,6	—	dB
	58,58 (58,50) MHz	—	0,4	—	dB
Adjacent picture carrier	53,83 (53,75) MHz	—	45,0	—	dB
Adjacent sound carrier	59,33 (59,25) MHz	—	11,0	—	dB
Lower sidelobe					
	45,08 ... 51,58 (45,00 ... 51,50) MHz	39,0	47,0	—	dB
	51,58 ... 53,83 (51,50 ... 53,75) MHz	32,0	40,0	—	dB
Upper sidelobe					
	60,03 ... 62,58 (59,95 ... 62,50) MHz	30,0	38,0	—	dB
	62,58 ... 65,08 (62,50 ... 65,00) MHz	37,0	43,0	—	dB
Reflected wave signal suppression					
1,2 μs ... 6,0 μs after main pulse (test pulse 250 ns, carrier frequency 57,08 MHz)		42,0	53,0	—	dB
Feedthrough signal suppression					
1,3 μs ... 1,2 μs before main pulse (test pulse 250 ns, carrier frequency 57,08 MHz)		—	50,0	—	dB
Group delay ripple (p-p)					
	$\Delta\tau$				
	55,68 ... 58,08 (55,60 ... 58,00) MHz	—	50	—	ns
Impedance at 57,08 MHz					
	Input: $Z_{\text{IN}} = R_{\text{IN}} \parallel C_{\text{IN}}$	—	0,4 24,0	—	k Ω pF
	Output: $Z_{\text{OUT}} = R_{\text{OUT}} \parallel C_{\text{OUT}}$	—	0,6 6,0	—	k Ω pF
Temperature coefficient of frequency					
	TC_f	—	-72	—	ppm/K



Data Sheet

Frequency response of channel 1

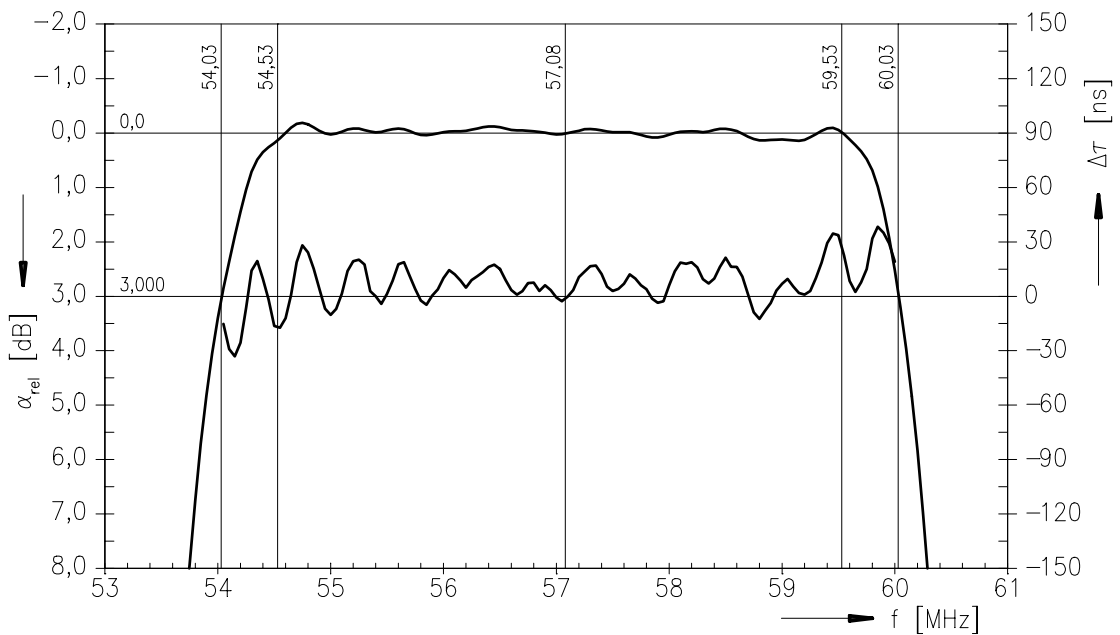
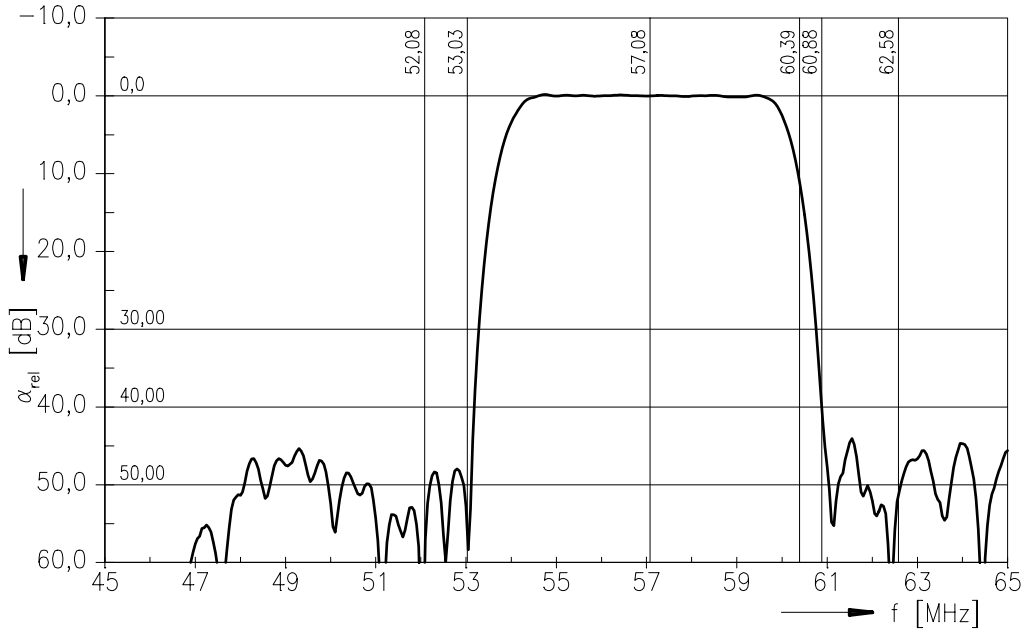



SAW Components

X 7256 D

Bandpass Filter

57,00 MHz

Data Sheet

Frequency response of channel 1

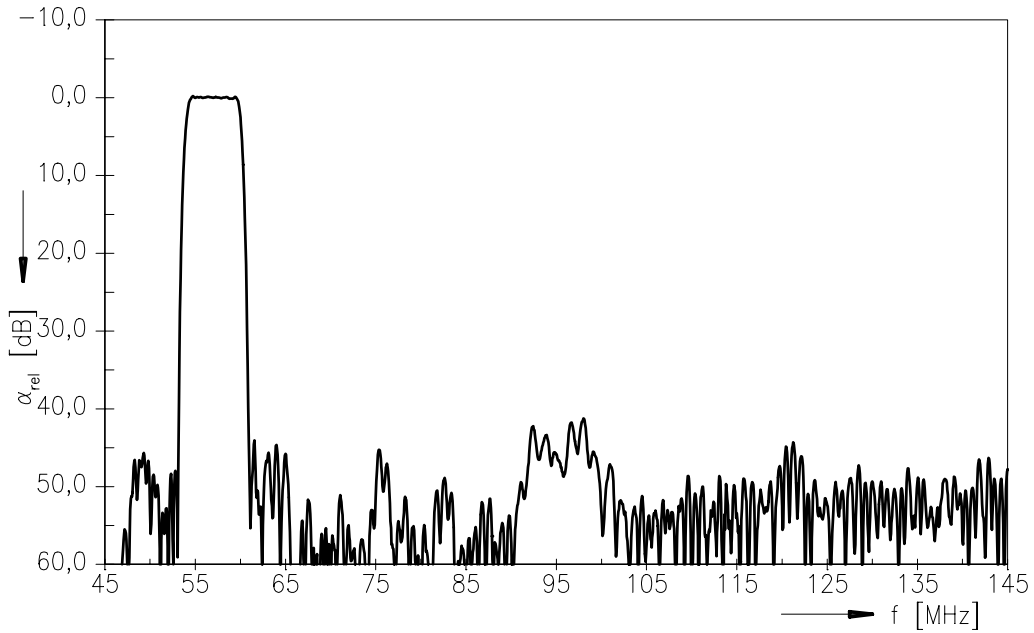

Time domain response of channel 1

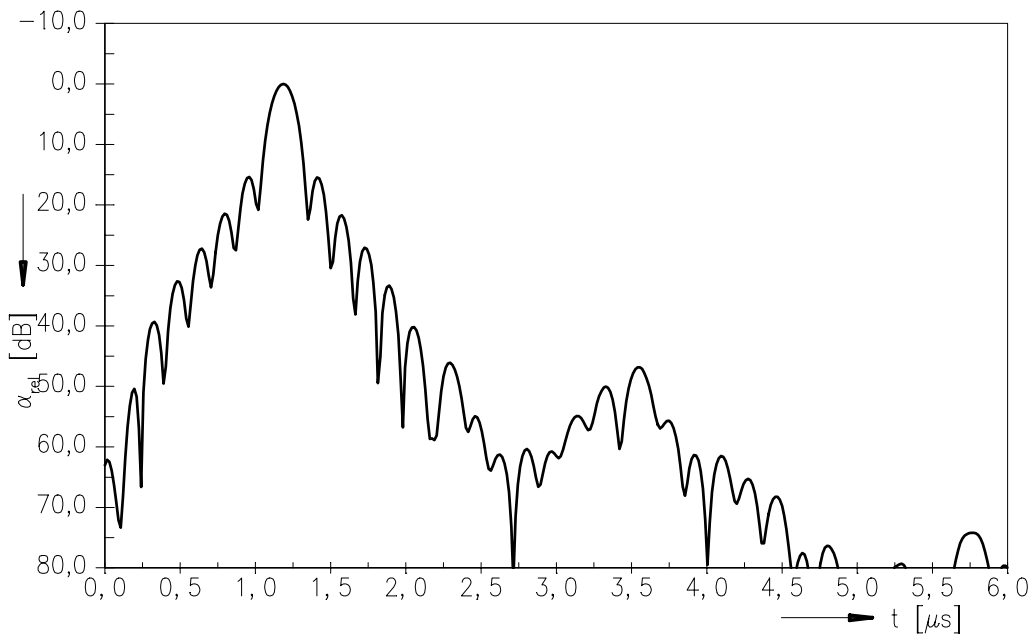



Data Sheet

Frequency response of channel 2

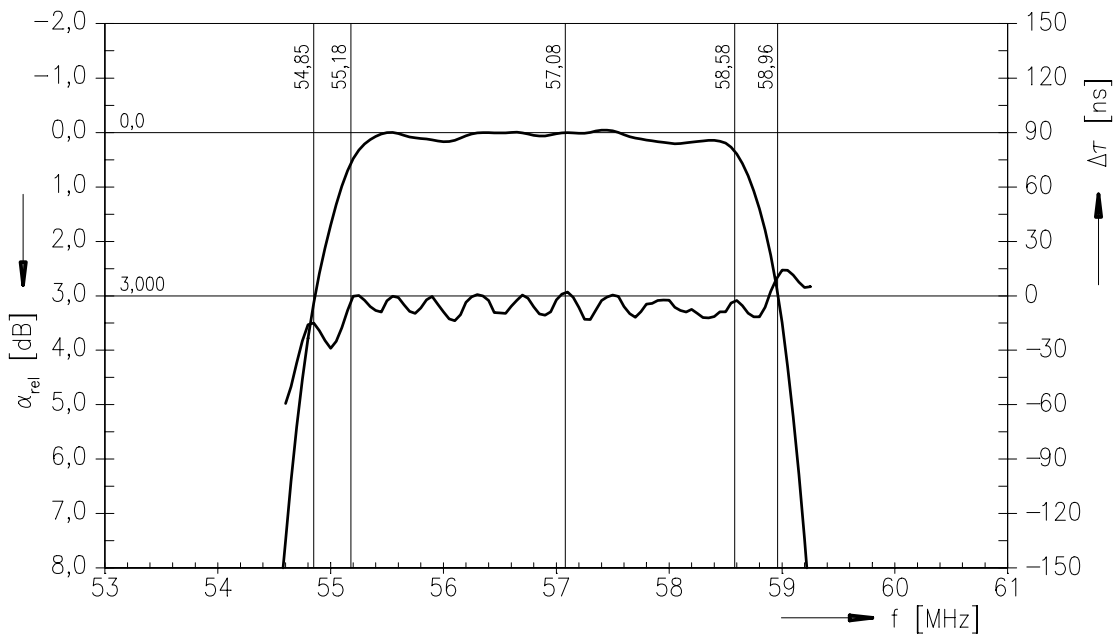
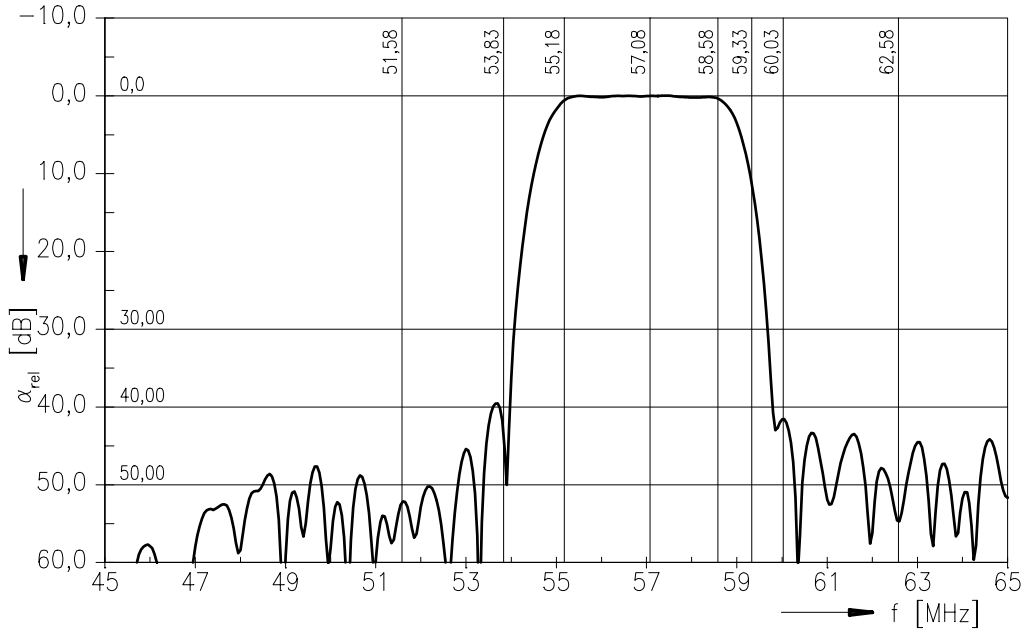



SAW Components

X 7256 D

Bandpass Filter

57,00 MHz

Data Sheet

Frequency response of channel 2

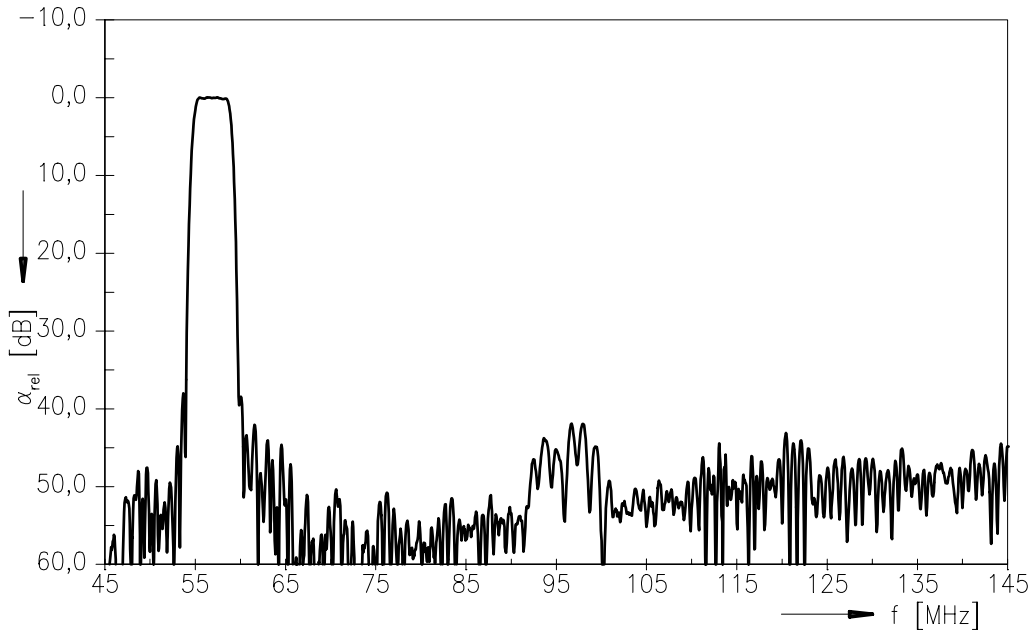

Time domain response of channel 2

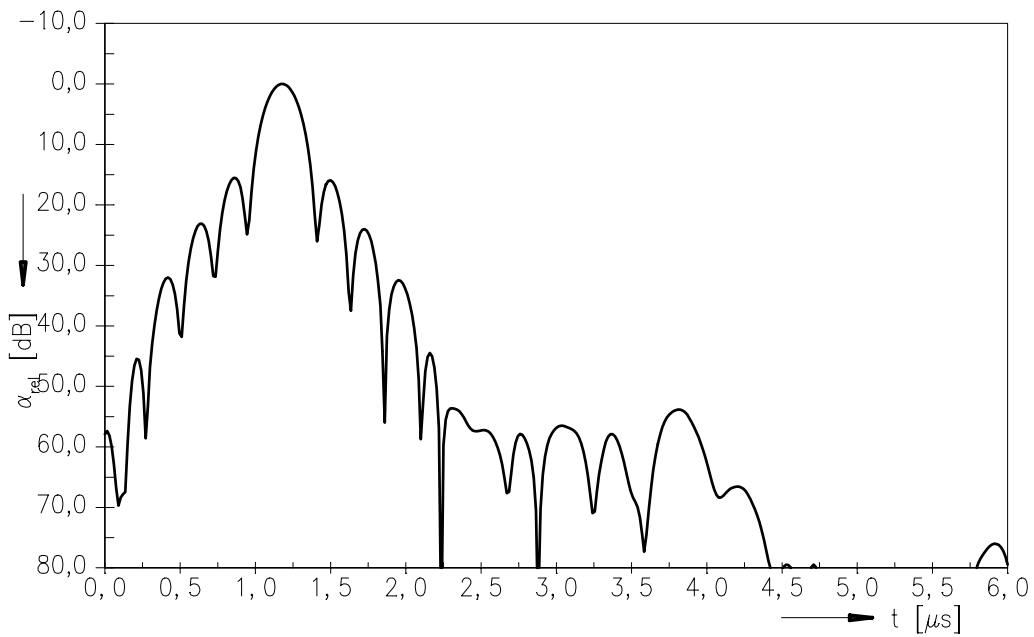



SAW Components

X 7256 D

Bandpass Filter

57,00 MHz

Data Sheet

Published by EPCOS AG

Surface Acoustic Wave Components Division, SAW CE MM PD

P.O. Box 80 17 09, 81617 Munich, GERMANY

© EPCOS AG 2005. Reproduction, publication and dissemination of this brochure and the information contained therein without EPCOS' prior express consent is prohibited.

Purchase orders are subject to the General Conditions for the Supply of Products and Services of the Electrical and Electronics Industry recommended by the ZVEI (German Electrical and Electronic Manufacturers' Association), unless otherwise agreed.

This brochure replaces the previous edition.

For questions on technology, prices and delivery please contact the Sales Offices of EPCOS AG or the international Representatives.

Due to technical requirements components may contain dangerous substances. For information on the type in question please also contact one of our Sales Offices.